

# PHILIPS

## Xitanium

### LED driver



## Datasheet

# Xitanium Outdoor LV LED Drivers Adjustable Current Independent Xitanium 200W 2.8-5.6A AOC 230V I250

Xitanium LV LED adjustable current drivers are specifically designed for maximum reliability and core flexibility in low voltage outdoor applications. With superior surge protection, these durable, independently housed drivers deliver consistent, high performance to luminaires even after multiple indirect lightning strikes – an ideal solution for OEMs that need reliable, adjustable output in a rugged independent form factor.

### Benefits

- Low voltage/high current output fits the application of LED strings connecting in parallel
- IP rated housing could be put into a gearbox without fully sealed
- Quick solution without luminaires re-design (perfect for tunnel lighting application)
- AOC (Adjustable Output Current) gives the full flexibility to output different currents to spec-in different projects
- Easy adjustment of output current/voltage by only one screwdriver
- Robust specifications for moisture, vibration and extreme temperature protection
- Consistent quality of light over life cycle.

### Features

- Robust anti-surge protection
- Outrush current limitation to protect module
- Adjustable output current with wide window
- High lifetime warranty at Tc Max and Tc Lifetime

### Applications

- Road and street lighting
- Area and flood lighting
- Tunnel lighting
- High-bay lighting

## Electrical input data

Specification item	Value	Unit	Condition
Nominal Input Voltage	220...240	V <sub>ac</sub>	
Input Voltage AC	198...264	V <sub>ac</sub>	Performance range
Operation Voltage AC	110...305	V <sub>ac</sub>	Safety operation
Nominal Input Frequency	50...60	Hz	
Input Frequency AC	47...63	Hz	Maximum permissible range
Nominal Input Current	0.9...1.09	A	220V...240V at full load
Maximum Input Current	1.12	A	At 202V
Nominal Input Power	218	W	At 230V at full load
Power Factor	0.95		At 230V at full load
Total Harmonic Distortion	< 20	%	At 230V at full load
Efficiency	91.5	%	At 230V at full load

## Electrical Output data

Specification item	Value	Unit	Condition
Regulation Method	Constant Current		
Output Voltage	18...71	V <sub>dc</sub>	
Output Voltage Max	80	V <sub>dc</sub>	Peak voltage at open circuit
Output Current	2.8...5.6	A	Performance range
Output Current Tolerance	5	%	At max. output current, T <sub>a</sub> =25 °C
Output Current Ripple LF	5	%	Ripple = peak / average, at <1kHz
Output Power	200	W	At full load
Galvanic Isolation	Yes		Double; 3750V

## Electrical data controls input

Specification item	Value	Unit	Condition
Control Method	N/A	V	
Digital Interface	N/A		According 2.0 specifications
Mains Control	N/A		Can be configured via MultiOne
Time-based Integrated Control	N/A		Can be configured via MultiOne
Dimming Range	N/A	%	

## Wiring & Connections

Specification item	Value	Unit	Condition
Input Wire Size	1.0	mm <sup>2</sup>	3-wire cable; 300V/500V rating or higher
Output Wire Size	1.5	mm <sup>2</sup>	2-wire cable; 300V/500V rating or higher
Input & Output Wire Length	450 ±30	mm	Out of enclosure
Control Wire Size	N/A	mm	N/A
Control Wire Length	N/A	mm	

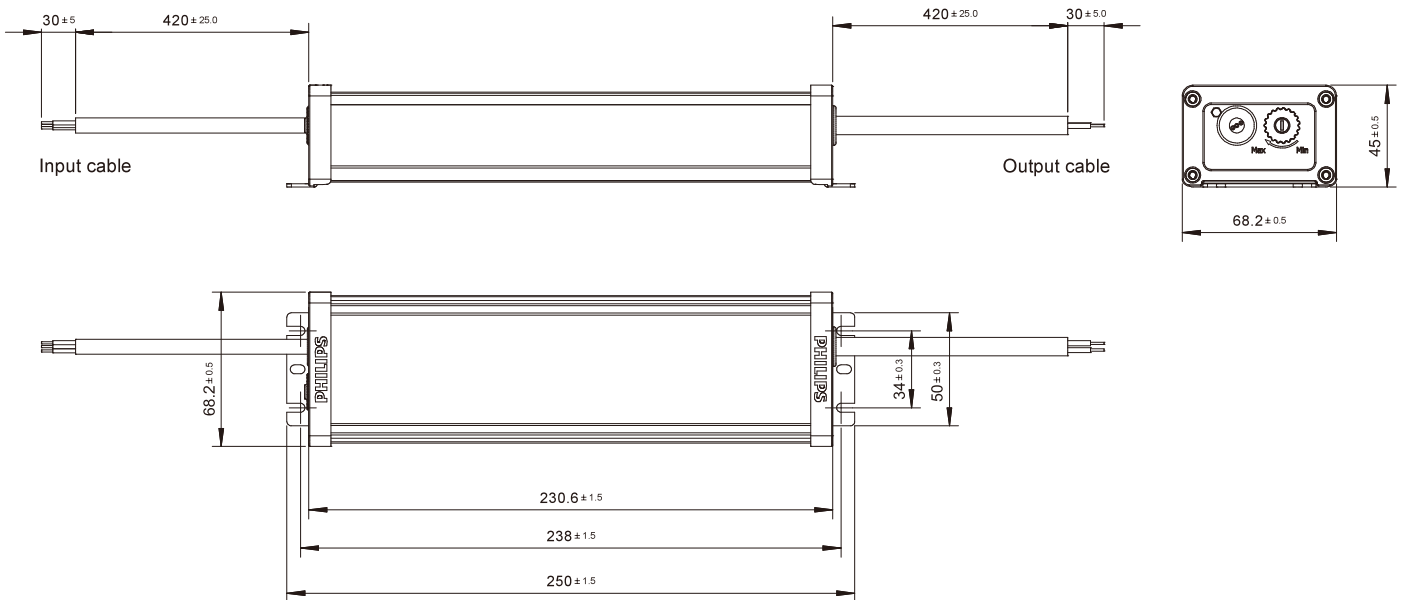

## CE Isolation

	Input Wires	Output Wires	Chassis
Input Wires	N/A	Double	Basic
Output Wires	Double	N/A	Basic
Chassis	Basic	Basic	N/A

## Operational Temperature and Humidity

Specification item	Value	Unit	Condition
Ambient Temperature	-40...+50	°C	
T <sub>case</sub> Maximum	85	°C	Measured at T <sub>c</sub> -point
T <sub>case</sub> Life	75	°C	Measured at T <sub>c</sub> -point
T <sub>case</sub> Cut-Off	90	°C	Power to LEDs is reduced

## Storage Temperature and Humidity

Specification item	Value	Unit	Condition
Ambient Temperature	-40...+50	°C	

## Lifetime

Specification item	Value	Unit	Condition
Lifetime	100,000	Hours	At T <sub>case</sub> Life; Survival rate = 90%

## Programmable Features

Specification item	Value	Remark	Condition
Adjustable Output Current (AOC)	N/A		See Design-In Guide
LED Module Temperature Derating (MTP)	N/A		
Constant Lumen Output (CLO)	N/A		
DC Emergency Dimming (DCEmDIM)	N/A		
Corridor Mode	N/A		
Energy Metering	N/A		
Diagnostics	N/A		

## Features

Specification item	Value	Remark	Condition
Over Temperature Protection	Yes	Dim Down	Automatic Recovery
Open Circuit Protection	Yes		Automatic Recovery
Short Circuit Protection	Yes		Automatic Recovery
Over Power Protection	Yes		
Hot Wiring	N/A		
Suitable for fixtures with Protection Class	Class I		

## Certificates and Standards

Specification item	Value
Approval Marks	CE / CB / CCC / KC / TISI / ENEC
Ingress Protection Rating	IP65

## Inrush current

Specification item	Value	Unit	Condition
Inrush Current Ipeak	62	A	At 230Vac
Inrush Current Twidth	684	$\mu$ s	At 230Vac, measured at 50% Ipeak
Drivers per MCB 16A Type B	4	pcs	

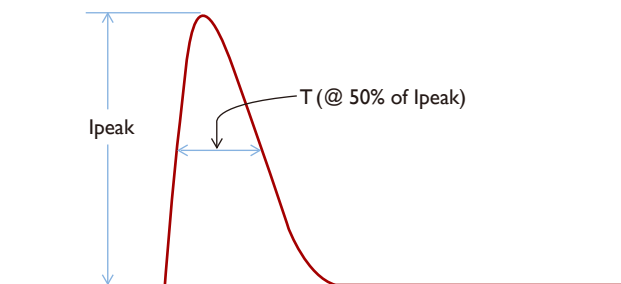

## Earth Leakage Current

Specification item	Value	Unit	Condition
Typical Touch Current	2	mApk	Meets IEC 60598; LED module not included

## Surge Capability

Specification item	Value	Unit	Condition
Mains Surge Capability Differential Mode	4	KV	L-N, 20hm
Mains Surge Capability Common Mode	6	KV	L/N-GND, 120hm

## Wiring & Connections

Specification item	Value	Unit	Condition
Length overall	250	mm	
Width overall	68.2	mm	
Height overall	45	mm	
Mounting Holes Distance	238	mm	
Mounting Holes Width	34	mm	
Mounting Holes Size	4	mm	For M4 with max head diameter of 10mm
Weight	920	g	

## Logistical Data

Specification item	Value
Product Name	Xitanium 200W 2.8-5.6A AOC 230V I250
Logistics Code 12NC	929001404680
Pieces per Box	10

## Graphs

### Operating window

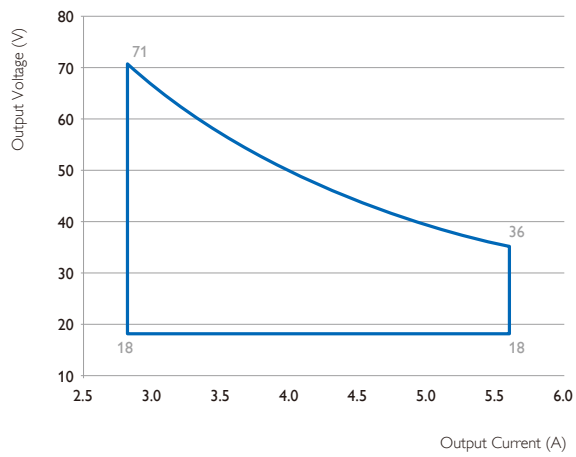

### Efficiency versus output power

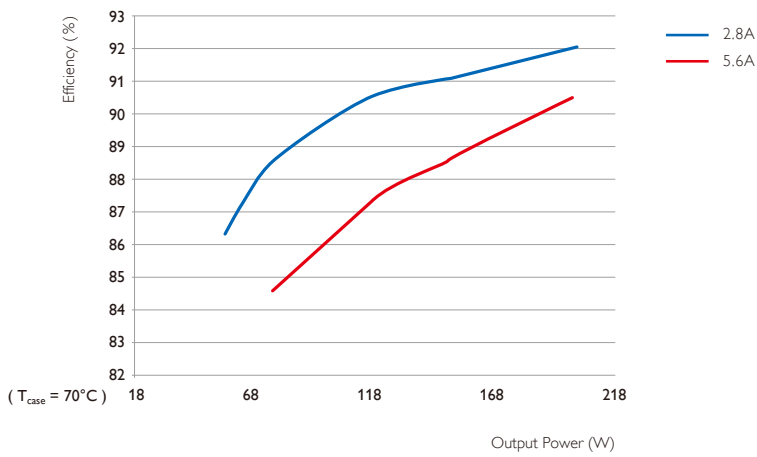

### Power factor versus output power

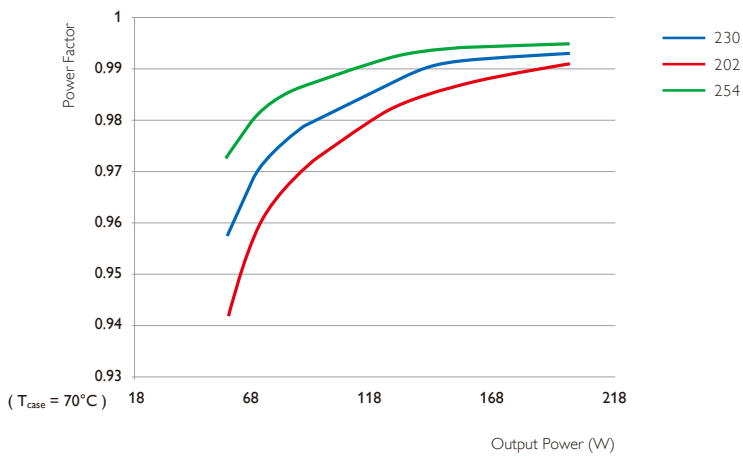

## Total Harmonic Distortion

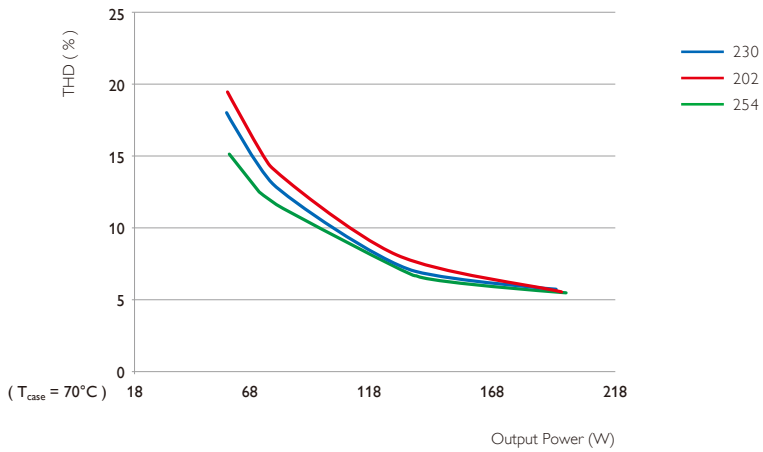

## Lifetime vs Tcase

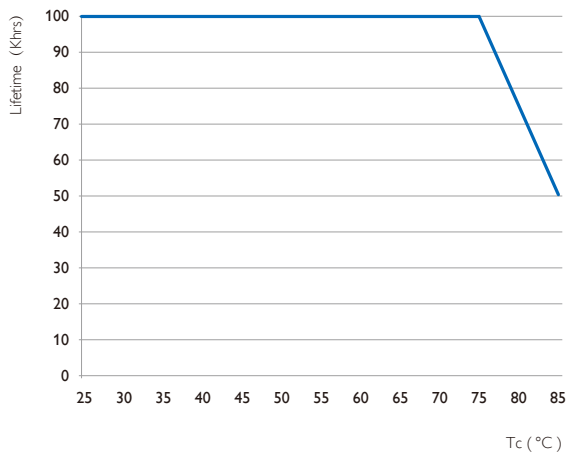

©2015 Koninklijke Philips Electronics N.V.

All rights reserved. Reproduction in whole or in part is prohibited without the prior written consent of the copyright owner. The information presented in this document does not form part of any quotation or contract, is believed to be accurate and reliable and may be changed without notice. No liability will be accepted by the publisher for any consequence of its use. Publication thereof does not convey nor imply any license under patent- or other industrial or intellectual property rights. Data subject to change.

Date of release: December 17, 2015

[www.philips.com](http://www.philips.com)